

SMP253 Series Metallized Impregnated Paper, Class Y2, 250 VAC, Surface Mount Device

Overview

The SMP253 Series is constructed of multilayer metallized paper, encapsulated and impregnated in self-extinguishing material meeting the requirements of UL 94 V-0.

Applications

Typical applications include worldwide use as electromagnetic interference suppressor in all Y2 applications, line-to-earth.

Benefits

- Approvals: S, UL, CSA
- Rated voltage: 250 VAC 50/60 Hz
- Capacitance range: 0.001 – 0.0047 μ F
- Size code: 5045, 12.7 mm
- Capacitance tolerance: \pm 20%
- Climatic category: 40/100/56/B, IEC 60068-1
- Tape and reel packaging in accordance with IEC 60286-3
- RoHS Compliant and lead-free terminations
- Operating temperature range of -40°C to +100°C
- 100% screening factory test at 3,000 VDC
- Highest possible safety regarding active and passive flammability
- Excellent self-healing properties ensure long life even when subjected to frequent over voltages
- Good resistance to ionization due to impregnated dielectric
- High dV/dt capability
- Impregnated paper ensures excellent stability and reliability properties, particularly in applications with continuous operation

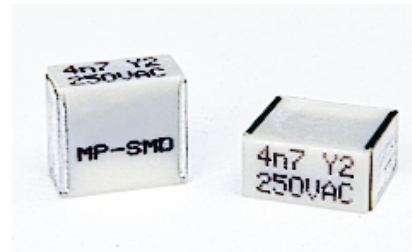

Legacy Part Number System

SMP253	M	A	4100	M	TR24
Series	Rated Voltage (VAC)	Chip Length (mm)	Capacitance Code (pF)	Capacitance Tolerance	Lead and Packaging Code
Y2, Metallized Paper	M = 250	A = 12.7	Digits 2 – 4(3) indicates the first three digits of the capacitance value. First digit indicates the total number of digits in the capacitance value.	M = \pm 20%	See Ordering Options Table

New KEMET Part Number System

P	101	AA	102	M	250	V
Capacitor Class	Series	Chip Size	Capacitance Code (pF)	Capacitance Tolerance	Rated Voltage (VAC)	Lead and Packaging Code
P = Paper	Y2, Metallized Paper	See Dimension Table	First two digits indicate the two most significant digits of the capacitance value in picofarads. The third digit is the number of following zeros.	M = \pm 20%	250 = 250	See Ordering Options Table

Ordering Options Table

Packaging Type	KEMET Lead and Packaging Code	Legacy Lead and Packaging Code
Standard Lead and Packaging Options		
Tape & Reel (Standard Reel)	V	TR24
Bulk (Bag)	A	BULK
Other Lead and Packaging Options		
Tape & Reel (Vertical Orientation Standard Reel)	Y	TV24

Dimensions – Millimeters

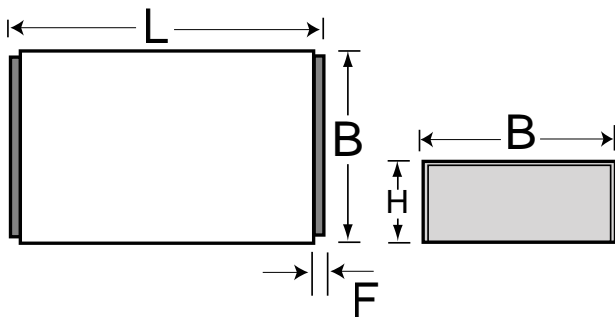

Chip Size	B		H		L		F	
	Nominal	Tolerance	Nominal	Tolerance	Nominal	Tolerance	Nominal	Tolerance
5045	11.5	+/-0.2	6.5	+/-0.2	12.7	+/-0.2	0.5	Nominal



Performance Characteristics

Rated Voltage	250 VAC 50/60 Hz	
Capacitance Range	0.001 – 0.0047 μ F	
Capacitance Tolerance	\pm 20%	
Temperature Range	-40°C to +100°C	
Climatic Category	40/100/56/B	
Approvals	S, UL, CSA	
Dissipation Factor	Maximum Values at +23°C	
	1 kHz	1.3%
Test Voltage Between Terminals	The 100% screening factory test is carried out at 3,000 VDC. The voltage level is selected to meet the requirements in applicable equipment standards. All electrical characteristics are checked after the test. It is not permitted to repeat this test as there is a risk to damage the capacitor. KEMET is not liable in such case for any failures.	
Insulation Resistance	Minimum Value Between Terminals	
	\geq 12,000 M Ω	

Environmental Test Data

Test	IEC Publication	Procedure
Vibration	IEC 60068–2–6 Test Fc	3 directions at 2 hours each 10 – 500 Hz at 0.75 mm or 98 m/s ²
Active Flammability	IEC 60384–14	
Passive Flammability	IEC 60384–14	Needle-flame test
Humidity	IEC 60068–2–3 Test Ca	+40°C and 90 – 95% RH

Approvals

Mark	Specification	File Number
	EN/IEC 60384–14	9949069/01
	UL 1283 (250 VAC)	E100117
	CSA – C22.2 No. 8 (250 VAC)	E100117

Environmental Compliance

All KEMET EMI capacitors are RoHS Compliant.



RoHS Compliant

Table 1 – Ratings & Part Number Reference

Capacitance Value (μF)	Maximum Dimensions in mm			dV/dt (V/μs)	New KEMET Part Number	Legacy Part Number
	B	H	L			
0.0010	11.5	6.5	12.7	2000	P101AA102M250(1)	SMP253MA4100M(1)
0.0015	11.5	6.5	12.7	2000	P101AA152M250(1)	SMP253MA4150M(1)
0.0022	11.5	6.5	12.7	2000	P101AA222M250(1)	SMP253MA4220M(1)
0.0025	11.5	6.5	12.7	2000	P101AA252M250(1)	SMP253MA4250M(1)
0.0033	11.5	6.5	12.7	2000	P101AA332M250(1)	SMP253MA4330M(1)
0.0039	11.5	6.5	12.7	2000	P101AA392M250(1)	SMP253MA4390M(1)
0.0047	11.5	6.5	12.7	2000	P101AA472M250(1)	SMP253MA4470M(1)
Capacitance Value (μF)	B (mm)	H (mm)	L (mm)	dV/dt (V/μs)	New KEMET Part Number	Legacy Part Number

(1) Insert packaging code. See Ordering Options Table for available options.

Soldering Process

Reflow soldering temperature shall be measured on the top body surface of the component. The profiles herewith are recommended soldering profiles for convection reflow ovens and IR reflow ovens. If vapor phase reflow oven is used, please consult KEMET. Exceeding the manufacturer’s process recommendations may harm the component. KEMET is not liable for any defect caused by exceeding recommendations. According to international standards, the maximum temperature capability shall be measured on the top surface of a component. The international standards do not define how the thermocouple should be fastened on the component. Our recommendation for attaching the thermocouple on the top surface of the component is to glue it with high temperature resistant glue.

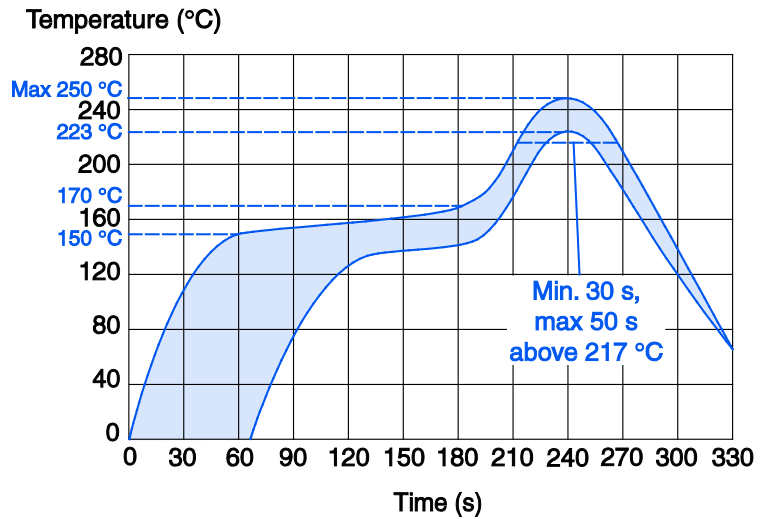

Marking

- KEMET’s logo
- Series
- Capacitance
- Rated voltage
- Capacitor class
- Manufacturing date code

Packaging Quantities

Chip Size EIA	Thickness (mm)	Height (mm)	Length (mm)	Standard Reel ø 330 mm	
				Horizontal Orientation	Vertical Orientation
5045	11.5	6.5	12.7	600	400

Carrier Taping & Packaging (IEC 60286–2)

Horizontal Taping Orientation

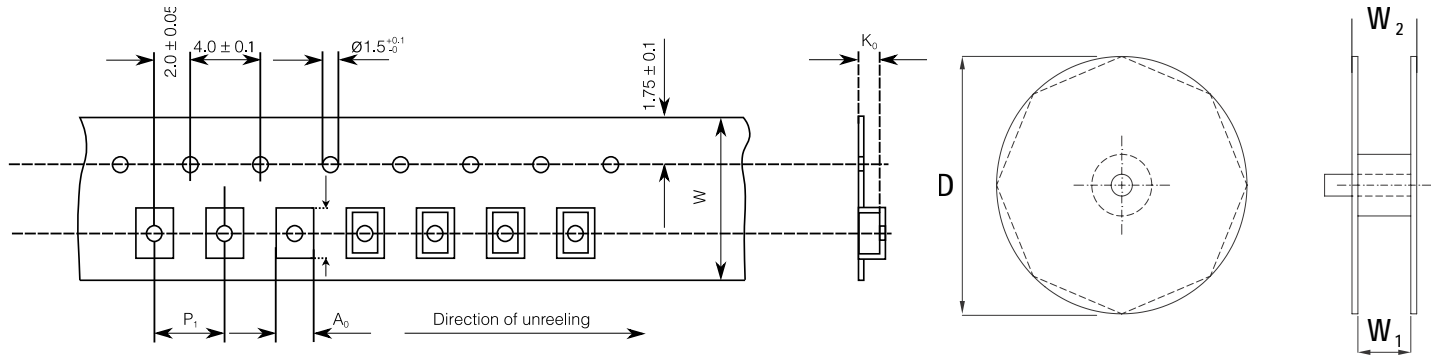

EIA Size Code Horizontal Mounting	Dimensions in mm			Taping Specification							
	B	H	L	W	P ₁	A ₀	B ₀	K ₀	D	W ₁	W ₂
	Nominal	Nominal	Nominal	-0/+0.3	+/-0.1	Nominal	Nominal	Nominal	-/+2.0	-0/+2	Maximum
5045	11.5	6.5	12.7	24.0	16.0	11.9	13.1	6.8	330	24.4	30.0

Vertical Taping Orientation

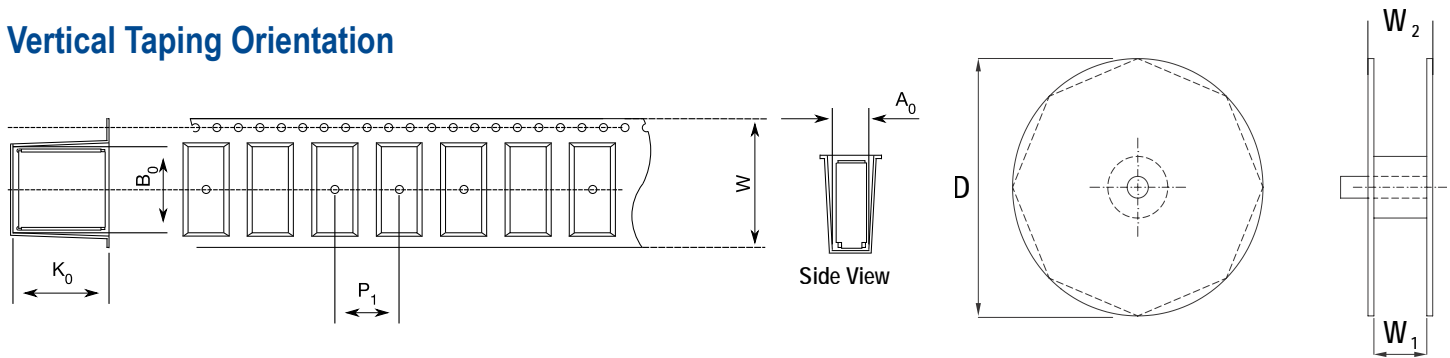

EIA Size Code Vertical Mounting	Dimensions in mm			Taping Specification							
	B	H	L	W	P ₁	A ₀	B ₀	K ₀	D	W ₁	W ₂
	Nominal	Nominal	Nominal	-0/+0.3	+/-0.1	Nominal	Nominal	Nominal	-/+2.0	-0/+2	Maximum
5026 (5045)	12.7	6.5	11.5	24.0	16.0	6.9	13.1	11.8	330	24.4	30.0

KEMET Corporation World Headquarters

2835 KEMET Way
Simpsonville, SC 29681

Mailing Address:
P.O. Box 5928
Greenville, SC 29606

www.kemet.com
Tel: 864-963-6300
Fax: 864-963-6521

Corporate Offices
Fort Lauderdale, FL
Tel: 954-766-2800

North America

Southeast
Lake Mary, FL
Tel: 407-855-8886

Northeast
Wilmington, MA
Tel: 978-658-1663

Central
Novi, MI
Tel: 248-994-1030

West
Milpitas, CA
Tel: 408-433-9950

Mexico
Guadalajara, Jalisco
Tel: 52-33-3123-2141

Europe

Southern Europe
Paris, France
Tel: 33-1-4646-1006

Sasso Marconi, Italy
Tel: 39-051-939111

Central Europe
Landsberg, Germany
Tel: 49-8191-3350800

Kamen, Germany
Tel: 49-2307-438110

Northern Europe
Bishop's Stortford, United Kingdom
Tel: 44-1279-460122

Espoo, Finland
Tel: 358-9-5406-5000

Asia

Northeast Asia
Hong Kong
Tel: 852-2305-1168

Shenzhen, China
Tel: 86-755-2518-1306

Beijing, China
Tel: 86-10-5829-1711

Shanghai, China
Tel: 86-21-6447-0707

Taipei, Taiwan
Tel: 886-2-27528585

Southeast Asia
Singapore
Tel: 65-6586-1900

Penang, Malaysia
Tel: 60-4-6430200

Bangalore, India
Tel: 91-806-53-76817

Note: KEMET reserves the right to modify minor details of internal and external construction at any time in the interest of product improvement. KEMET does not assume any responsibility for infringement that might result from the use of KEMET Capacitors in potential circuit designs. KEMET is a registered trademark of KEMET Electronics Corporation.

Other KEMET Resources

Tools	
Resource	Location
Configure A Part: CapEdge	http://capacitoredge.kemet.com
SPICE & FIT Software	http://www.kemet.com/spice
Search Our FAQs: KnowledgeEdge	http://www.kemet.com/keask
Electrolytic LifeCalculator	http://www.kemet.com:8080/elc

Product Information	
Resource	Location
Products	http://www.kemet.com/products
Technical Resources (Including Soldering Techniques)	http://www.kemet.com/technicalpapers
RoHS Statement	http://www.kemet.com/rohs
Quality Documents	http://www.kemet.com/qualitydocuments

Product Request	
Resource	Location
Sample Request	http://www.kemet.com/sample
Engineering Kit Request	http://www.kemet.com/kits

Contact	
Resource	Location
Website	www.kemet.com
Contact Us	http://www.kemet.com/contact
Investor Relations	http://www.kemet.com/ir
Call Us	1-877-MyKEMET
Twitter	http://twitter.com/kemetcapacitors

Disclaimer

All product specifications, statements, information and data (collectively, the "Information") in this datasheet are subject to change. The customer is responsible for checking and verifying the extent to which the Information contained in this publication is applicable to an order at the time the order is placed.

All Information given herein is believed to be accurate and reliable, but it is presented without guarantee, warranty, or responsibility of any kind, expressed or implied.

Statements of suitability for certain applications are based on KEMET Electronics Corporation's ("KEMET") knowledge of typical operating conditions for such applications, but are not intended to constitute – and KEMET specifically disclaims – any warranty concerning suitability for a specific customer application or use. The Information is intended for use only by customers who have the requisite experience and capability to determine the correct products for their application. Any technical advice inferred from this Information or otherwise provided by KEMET with reference to the use of KEMET's products is given gratis, and KEMET assumes no obligation or liability for the advice given or results obtained.

Although KEMET designs and manufactures its products to the most stringent quality and safety standards, given the current state of the art, isolated component failures may still occur. Accordingly, customer applications which require a high degree of reliability or safety should employ suitable designs or other safeguards (such as installation of protective circuitry or redundancies) in order to ensure that the failure of an electrical component does not result in a risk of personal injury or property damage.

Although all product-related warnings, cautions and notes must be observed, the customer should not assume that all safety measures are indicated or that other measures may not be required.

