

MINIATURE SIGNAL RELAY UA2/UB2 SERIES

Super-compact size, Slim-package, Surface mounting type

DESCRIPTION

NEC's UA2/UB2 relay is a new generation Miniature Signal Relay of super-compact size and slim-package.

FEATURES

- Small mounting size of slim package for dense mounting.
- Bellcore (2500 V) and FCC (1500 V) surge capability.
- IEC950/UL1950/EN60950 spacing and high breakdown voltage.
(Basic insulation class on 200 V working voltage)
- Low power consumption 140 mW

APPLICATIONS

Electronic switching systems, PBX, terminal equipment, telephone system, instrumental equipment.

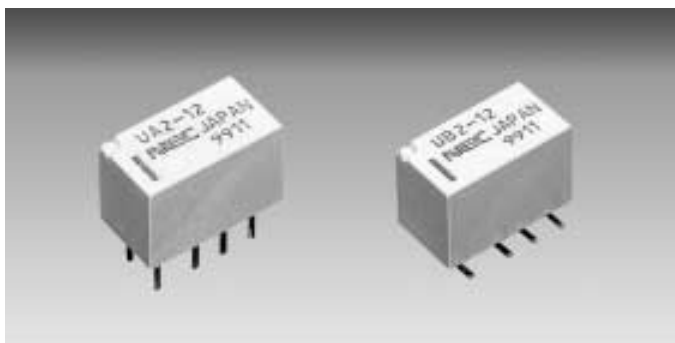

For Right Use of Miniature Relays

DO NOT EXCEED MAXIMUM RATINGS.

Do not use relays under exceeding conditions such as over ambient temperature, over voltage and over current. Incorrect use could result in abnormal heating, damage to related parts or cause burning.

READ CAUTIONS IN THE SELECTION GUIDE.

Read the cautions described in NEC's "Miniature Relays" (ER0046EJ*) when you choose relays for your application.

The information in this document is subject to change without notice.

DIMENSIONS AND PAD LAYOUTS (Unit : mm [inch])

UA2 SERIES

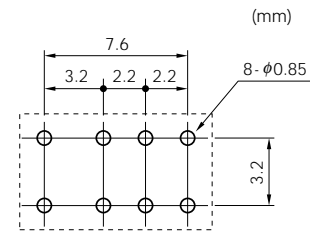
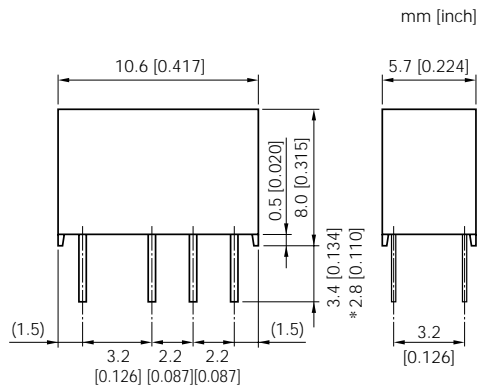

(Bottom view)

Note. General tolerance : ± 0.1

Tolerance of lead pitch is ± 0.15 mm [0.006 inch]
 Another tolerance is ± 0.3 mm [0.012 inch]
 () is reference.
 * Value of trimmed lead type (NJ type)

UB2 SERIES

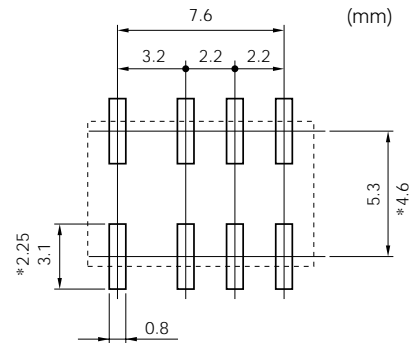
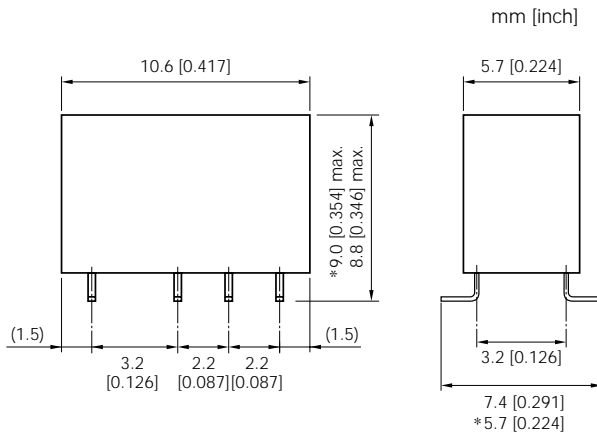

(Bottom view)

Note. General tolerance : ± 0.1

Tolerance of lead pitch is ± 0.15 mm [0.006 inch]
 Another tolerance is ± 0.3 mm [0.012 inch]
 () is reference.
 * Value of minimum footprint type (NUN type)

PIN CONFIGURATIONS (bottom view)

UA2 SERIES

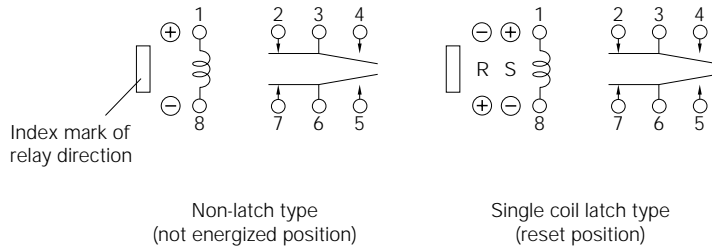

S : Coil polarity of set (operate)
R : Coil polarity of reset (release)

UB2 SERIES

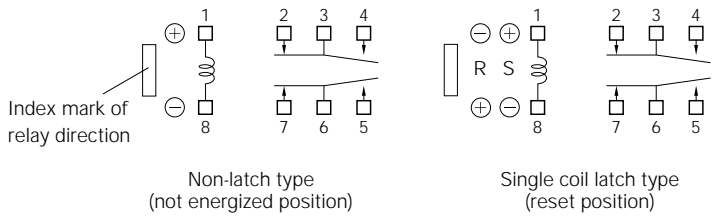

S : Coil polarity of set (operate)
R : Coil polarity of reset (release)

MARKINGS (top view)

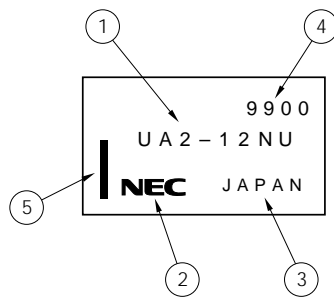

- ① Part number
- ② Manufacturer
- ③ Country of origin
- ④ Date code
- ⑤ Index mark of relay direction
(pin No. 1, 12)

PERFORMANCE CHARACTERISTICS (Community)

Contact Form		2 Form c	
Contact Ratings	Maximum Switching Power	30 W (resistive)	37.5 VA (resistive)
	Maximum Switching Voltage	220 Vdc	250 Vac
	Maximum Switching Current	1 A	
	Maximum Carrying Current	1 A	
Minimum Contact Ratings		10 mV.d.c, 10 μ A *4	
Initial Contact Resistance		100 m Ω Max. (Initial)	
Contact Material		Silver alloy with gold alloy overlay	
Nominal Operating Power	Non-Latch Type	140 to 230 mW	
	Single Coil Latch Type	100 to 120 mW	
Operate Time (Excluding Bounce)		Approximately 2 ms	
Release Time (Excluding Bounce)		Approximately 1 ms without diode	
Insulation Resistance		1000 M Ω at 500 Vdc	
Breakdown Voltage	Between Open Contacts	1000 Vac for one minute (1500 V surge, 10 \times 160 μ s *1)	
	Between Adjacent Contacts		
	Between Coil and Contact	1500 Vac for one minute (2500 V surge, 2 \times 10 μ s *2)	
Shock Resistance		735 m / s ² (misoperating) 980 m / s ² (destructive failure)	
Vibration Resistance		10 to 55 Hz at double amplitude of 3 mm (misoperating) 10 to 55 Hz, double amplitude of 5 mm (Destructive failure)	
Ambient Temperature		-40 to +85 $^{\circ}$ C	
Coil Temperature Rise		18 degrees at nominal coil voltage (140 mW)	
Running specifications	No-load	5 \times 10 ⁷ *3 operations (Non-latch type)	
		1 \times 10 ⁷ operations (Latch type)	
	Load	30 Vdc 1 A (resistive), 1 \times 10 ⁵ operations at 20 $^{\circ}$ C	
		125 Vac 0.3 A (resistive), 1 \times 10 ⁵ operations at 20 $^{\circ}$ C	
Weight		Approximately 1 grams	

*1 rise time : 10 μ s, fall time : 160 μ s

*2 rise time : 2 μ s, fall time : 10 μ s

*3 This shows a number of operation where it can be running by which a fatal is not caused, and number of operation by which a steady characteristic is maintained is 1 \times 10⁷ times.

*4 This value is a reference value in the resistive load.

Minimum capacity changes depending on switching frequency and environment temperature and the load.

SAFETY STANDARD AND RATING

UL Recognized (UL508)* File No E73266	CSA Certified (CSA C22.2 No14)* File No LR46266
30 Vdc, 1 A (Resistive) 110 Vdc, 0.3 A (Resistive) 125 Vac, 0.3 A (Resistive)	

* Spacing : UL114, UL478

☆ Spacing : CSAstd950

TUV Certified (EN61810)
No.2050596
Creepage and clearance of coil to contact is over than 2 mm (According EN60950)
Basic insulation class

RECOMMENDED RELAY DRIVE CONDITIONS

Drive under conditions. If it is impossible, please inquire to NEC.

Nonlatch type	Voltage : with \pm 5% at nominal voltage	Ambient temperature -40 to +85 $^{\circ}$ C
Single coil latch type	Square pulse (rise and fall time is rapidly)	
	pulse height : within \pm 5% at nominal voltage pulse width : more than 10 ms	

PART NUMBER SYSTEM

UB2 - 3 S N U - L

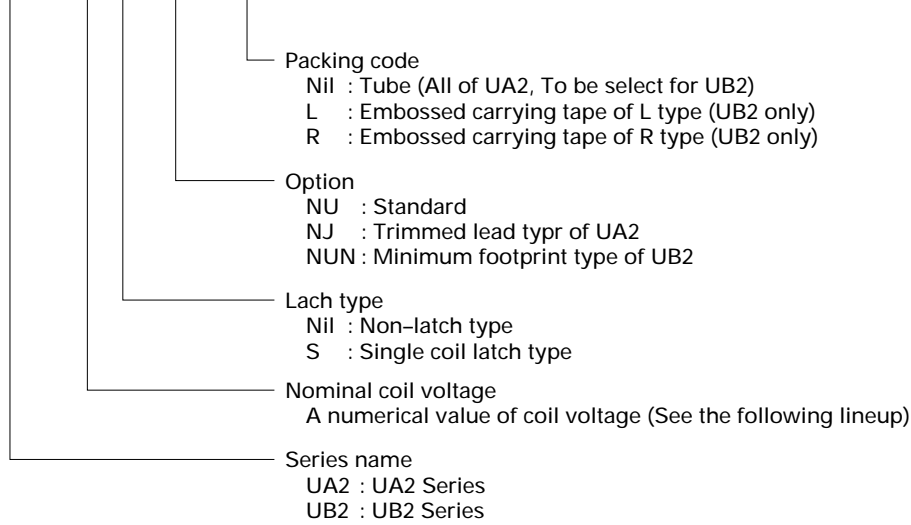

NOMINAL LINEUP

Non-latch Type

at 20°C

Nominal Coil Voltage (Vdc)	Coil Resistance (Ω) ±10 %	Must Operate Voltage (Vdc)	Must Release Voltage (Vdc)	Nominal operate power (mW)
1.5	16	1.13	0.15	140
3	64.3	2.25	0.3	140
4.5	145	3.38	0.45	140
5	178	3.75	0.5	140
6	257	4.5	0.6	140
9	579	6.75	0.9	140
12	1028	9.0	1.2	140
24	2504	18.0	2.4	230

Single-Coil Latch Type

at 20°C

Nominal Coil Voltage (Vdc)	Coil Resistance (Ω) ±10 %	Must Operate Voltage (Vdc)	Must Release Voltage (Vdc)	Nominal operate power (mW)
1.5	22.5	1.13	1.13	100
3	90	2.25	2.25	100
4.5	202.5	3.38	3.38	100
5	250	3.75	3.75	100
6	360	4.5	4.5	100
9	810	6.75	6.75	100
12	1440	9.0	9.0	100
24	4800	18.0	18.0	120

Coile Temperature Rise

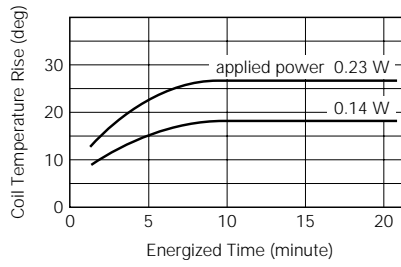
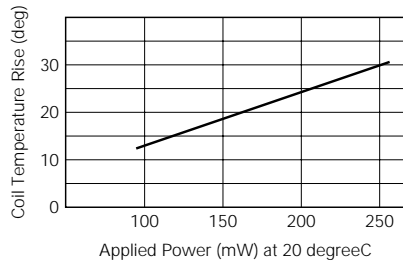

Switching capacity

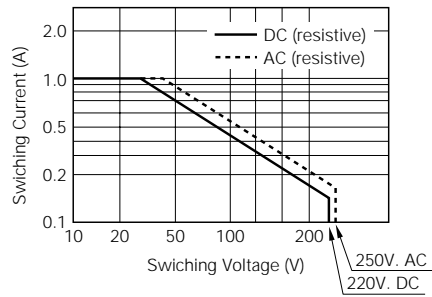

Maximum coil voltage

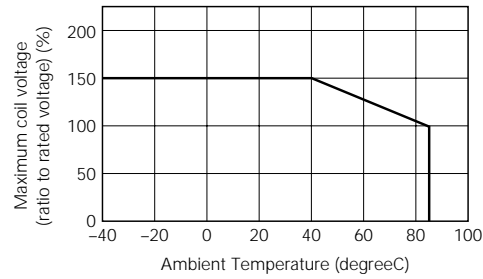

Operate Time and Release Time (Sample : UA2-5NU)

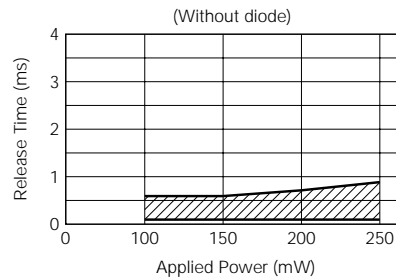
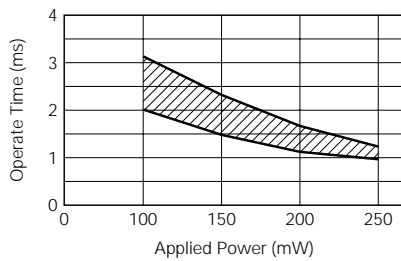

Nonload (mechanical) Life Test

(Load: Nonload, Drive: 5VDC 10 Hz 50% duty, at 20 degreeC, Sample: UA2-5 n=20)

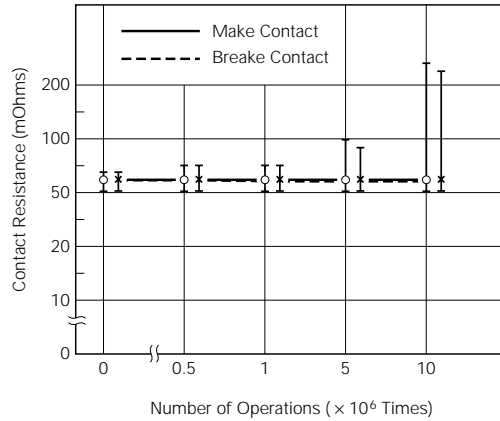
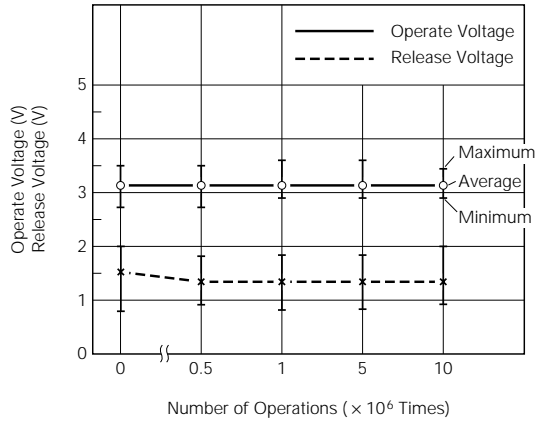

Electrical Life Test

(Load: 5VDC/0.1 A Resistive, Drive: 5VDC 5 Hz 50% duty, at 85 degreeC, Sample: UA2-5NU n=10)

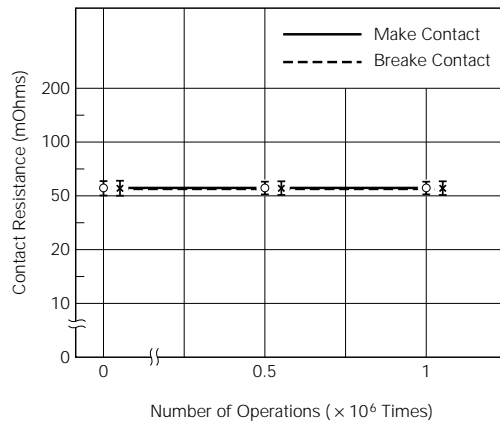
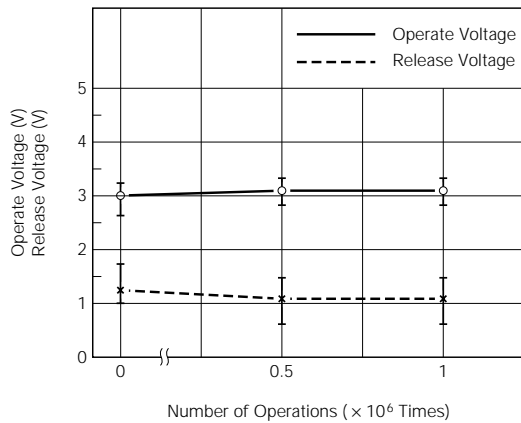

Breakdown Voltage

Sample : UA2-5NU

(a) Between open contact (sample : n=20)

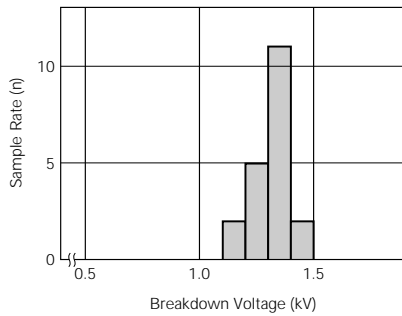

(b) Between adjacent contact (sample : n=10)

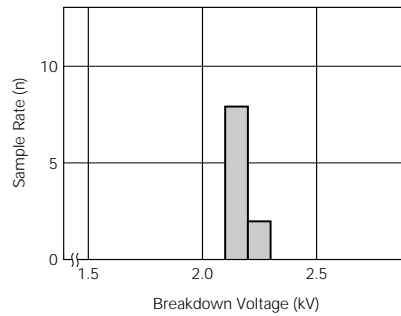

(c) Between coil to contact (sample : n=10)

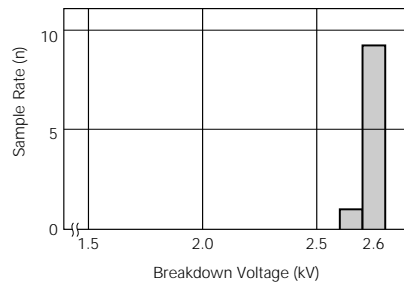

Magnetic Interference

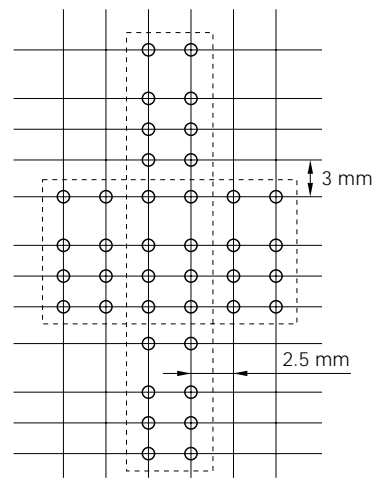
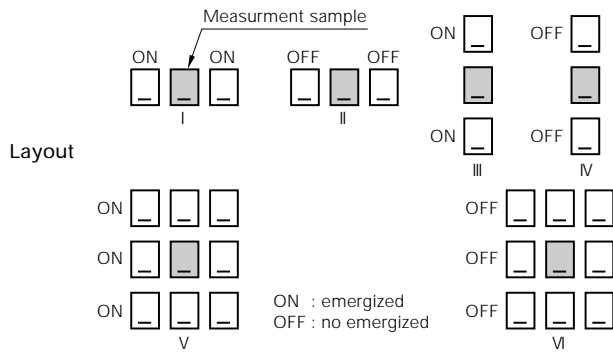
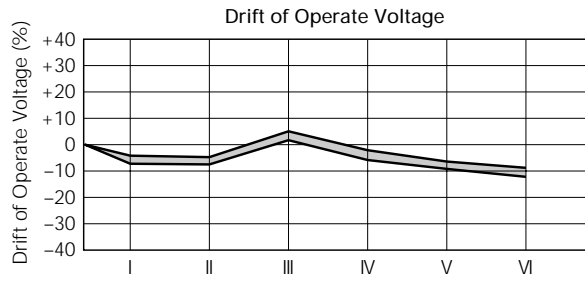
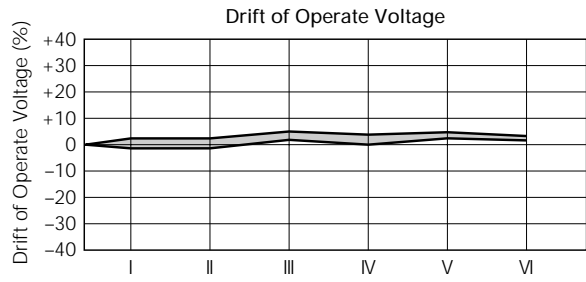

Mounting space

TUBE PACKAGE (UA2, UB2)

Dimension of Package (Unit : mm)

50 pieces / Tube
Material : Polyvinyl chloride
(anti-static treated)

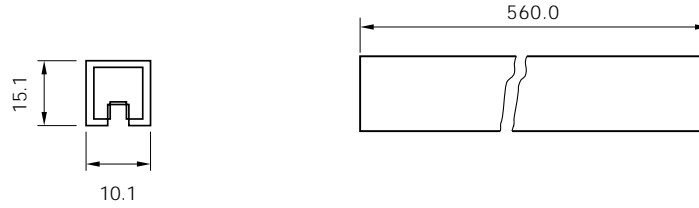

Outline of Package

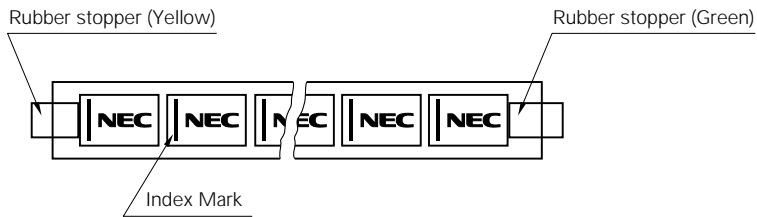

TAPE PACKAGE (UB2)

APPEARANCE

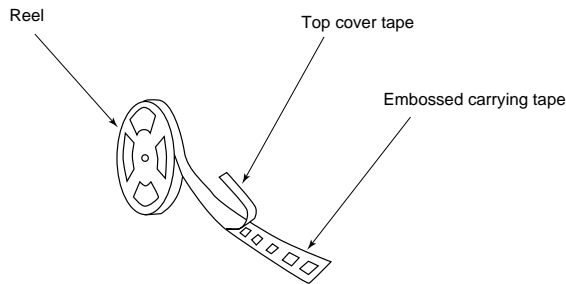

TAPE DIMENSION mm (inch)

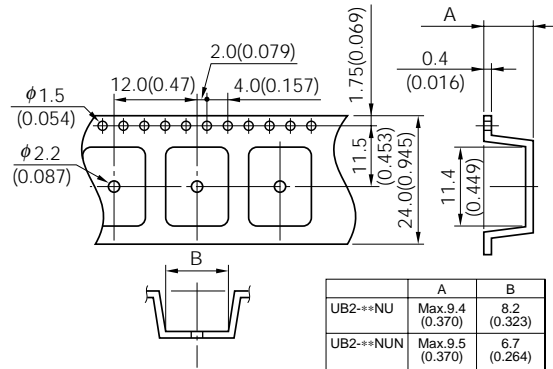

Relay orientation mark and tape carrying direction.

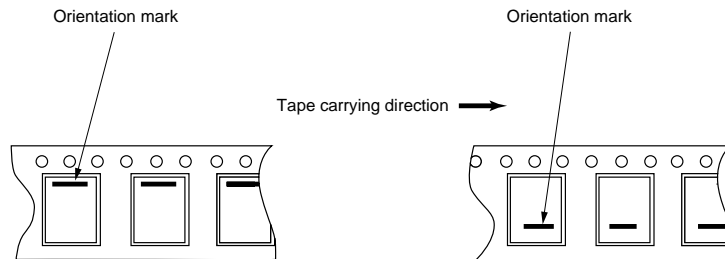

Carrying tape type L
Part number UB2-****-L

R
UB2-****-R

SOLDERING TEMPERATURE CONDITION

Through-hole mounting type (UA2)

- ① Automatic soldering
 - * Preheating : 100°C max. 1 minute max.
 - * Solder temperature : 250°C max.
 - * Solder time : 10 seconds max.
- ② Manual soldering
 - * Solder temperature : 350°C max.
 - * Solder time : 3 seconds max.

Surface mounting type (UB2)

IRS Method

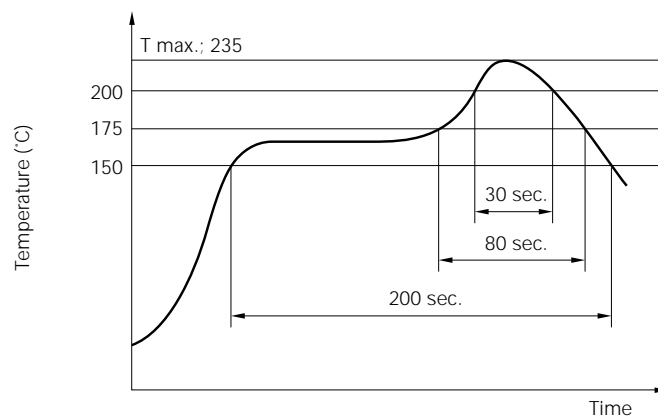

Note:

1. Temperature profile shows printed circuit board surface temperature on the relay terminal portion.
2. Check the actual soldering condition to use other method except above mentioned temperature profiles.

GUIDE TO APPLICATIONS

1. When connecting coils, refer to the pin configuration to prevent misoperation or malfunction.
2. The latch type relay should be initialized at the appointed position (set or reset position) when using, and should be energized or deenergized to the specified polarity to avoid wrong operations by reversed contact state.
3. Ultrasonic cleaning is not recommended to keep contact performance reliable. Alcohol based solvents are available as proper solvents.
4. Pressurized stress on the relay cover may affect reliable operation.
5. Minimum contact load of the relay is 10 mVdc, 10 μ A.
This value is a reference value in the resistance load.
Minimum capacity changes depending on switching frequency and environment temperature and the load.

No part of this document may be copied or reproduced in any form or by any means without the prior written consent of NEC Corporation. NEC Corporation assumes no responsibility for any errors which may appear in this document.

NEC Corporation does not assume any liability for infringement of patents, copyrights or other intellectual property rights of third parties by or arising from use of a device described herein or any other liability arising from use of such device. No license, either express, implied or otherwise, is granted under any patents, copyrights or other intellectual property rights of NEC Corporation or others.

While NEC Corporation has been making continuous effort to enhance the reliability of its electronic components, the possibility of defects cannot be eliminated entirely. To minimize risks of damage or injury to persons or property arising from a defect in an NEC electronic component, customers must incorporate sufficient safety measures in its design, such as redundancy, fire-containment, and anti-failure features. NEC devices are classified into the following three quality grades:

"Standard", "Special", and "Specific". The Specific quality grade applies only to devices developed based on a customer designated "quality assurance program" for a specific application. The recommended applications of a device depend on its quality grade, as indicated below. Customers must check the quality grade of each device before using it in a particular application.

Standard: Computers, office equipment, communications equipment, test and measurement equipment, audio and visual equipment, home electronic appliances, machine tools, personal electronic equipment and industrial robots

Special: Transportation equipment (automobiles, trains, ships, etc.), traffic control systems, anti-disaster systems, anti-crime systems, safety equipment and medical equipment (not specifically designed for life support)

Specific: Aircrafts, aerospace equipment, submersible repeaters, nuclear reactor control systems, life support systems or medical equipment for life support, etc.

The quality grade of NEC devices is "Standard" unless otherwise specified in NEC's Data Sheets or Data Books. If customers intend to use NEC devices for applications other than those specified for Standard quality grade, they should contact an NEC sales representative in advance.

(Note)

(1) "NEC" as used in this statement means NEC Corporation and also includes its majority-owned subsidiaries.

(2) "NEC electronic component products" means any electronic component product developed or manufactured by or for NEC (as defined above).

DE0202