

REV. Status

REVISION -
08/14/96 TS

REVISION A
REFORMATTED
08/14/96 TS

REVISION B
REFORMATTED
07/15/97 TS

REVISION C
CHANGED A.7.
08/20/99 TS

THREE FLANGE SINGLE PRIMARY 6.0VA PC BOARD POWER TRANSFORMER

A. Electrical Specifications (@ 25°C)

1. Maximum Power: 6.0 VA
2. Input Voltage and Frequency: 115V 50/60 Hz
3. Secondary Voltage: See Table A
4. Voltage Regulation: 18% TYP @ full load to no load
5. Temperature Rise: 35°C TYP (45°C MAX allowed)
6. Insulation Resistance:
100 MΩ MIN @ 500VDC, Pri to Sec, Pri to Core
100 MΩ MIN @ 500VDC, Sec to Core
7. Hi-Pot: 2500 Vrms 1 minute @ Pri to Sec
1500 Vrms 1 minute @ Pri to Core
1500 Vrms 1 minute @ Sec to Core
500 Vrms 1 minute @ Sec to Sec

B. Marking: TAMURA, Tamura part number (see sheet 2),
MICROTRAN, Microtran part number (see sheet 2),
date code, country of origin, safety logos and
input and output ratings

C. Safety:

- Insulation Class B (130°C) File No. E92957
- CSA 22.2 Nos. 0 and 66, File No. LR69808
- UL 1585, Class II and III, File No. E95844
- UL 506, General Purpose, File No. E91239

D. Mechanical Specifications:

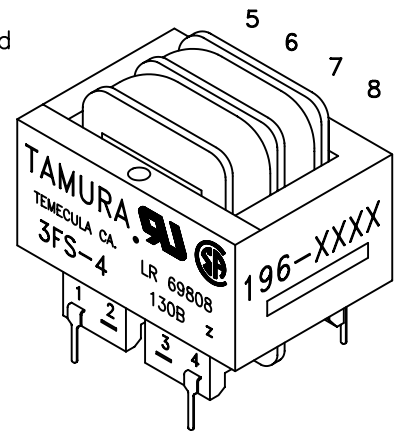

MODEL NUMBER

3FS-4XX & PSS4-XX

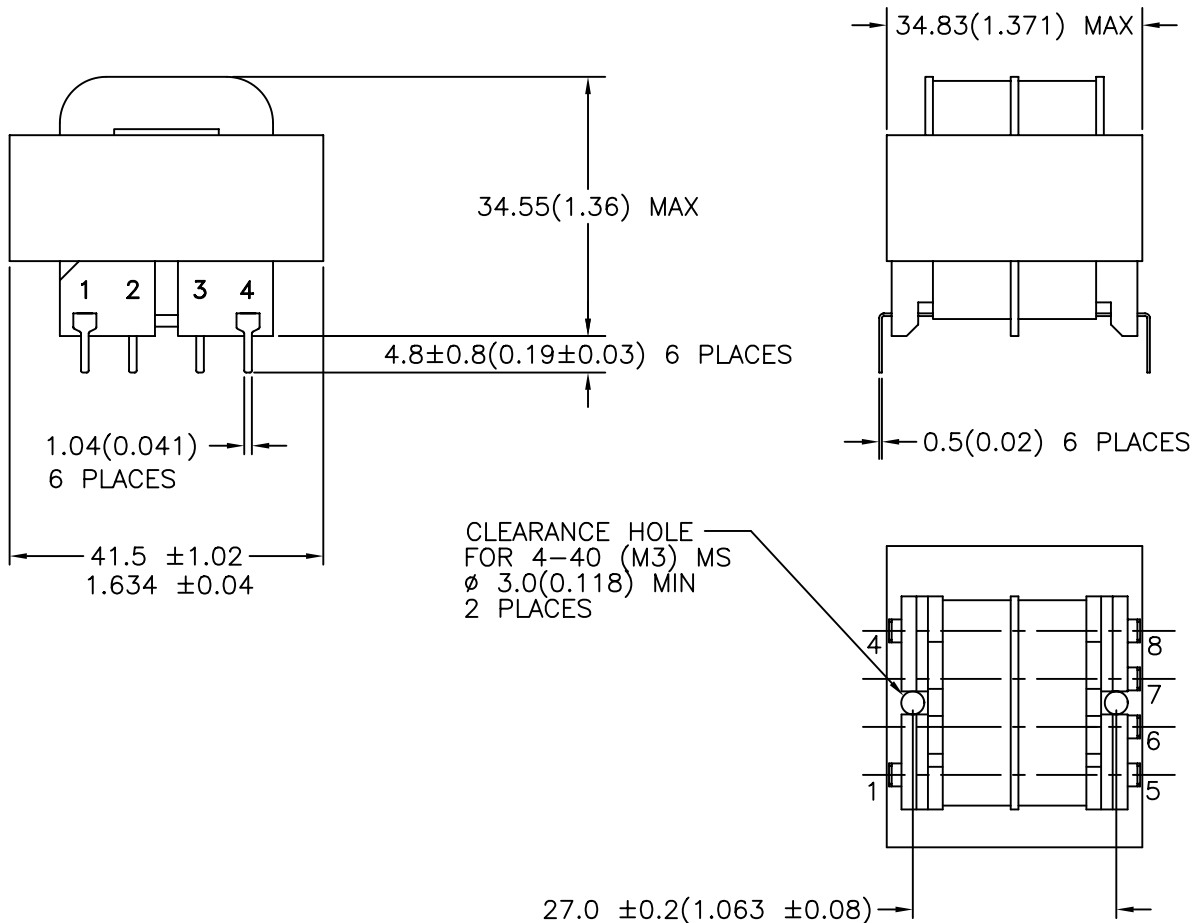

PREPARED BY:

D. Rund

ENGINEER:

T. Shiozawa

QUALITY CONTROL:

D. Kelley

APPROVED:

D. Kelley

DRAWING CONTROL NO.
P-A1-11647
ACAD\3F\A1116471.DWG

REV
C

MODEL DESCRIPTION
SIZE 4 3FS & PSS FAMILY
POWER TRANSFORMER
TAMURA CORPORATION OF AMERICA
43352 BUSINESS PARK DRIVE, TEMECULA, CA. 92590-6624
(909) 699-1270 FAX 9096769482

MODEL SPECIFICATION
3FS-4XX & PSS4-XX

DIM: mm(In) SCL: NONE SH: 1 OF 2

PROPRIETARY NOTICE: THIS DRAWING PRINT OR DOCUMENT AND SUBJECT MATTER DISCLOSED HEREIN ARE PROPRIETARY ITEMS TO WHICH TAMURA RETAINS THE EXCLUSIVE RIGHT OF DISSEMINATION, REPRODUCTION, MANUFACTURE AND SALE. THIS DRAWING, PRINT OR DOCUMENT IS SUBMITTED IN CONFIDENCE FOR CONSIDERATION BY THE RECIPIENT ALONE UNLESS PERMISSION FOR FURTHER DISCLOSURE IS EXPRESSLY GRANTED IN WRITING.

REV. Status

REVISION -
08/14/96 TS

REVISION A
REFORMATTED
08/22/96 TS

REVISION B
REFORMATTED
07/15/97 TS

REVISION C
CHANGED A.7.
08/20/99 TS

E. Mounting Footprint:

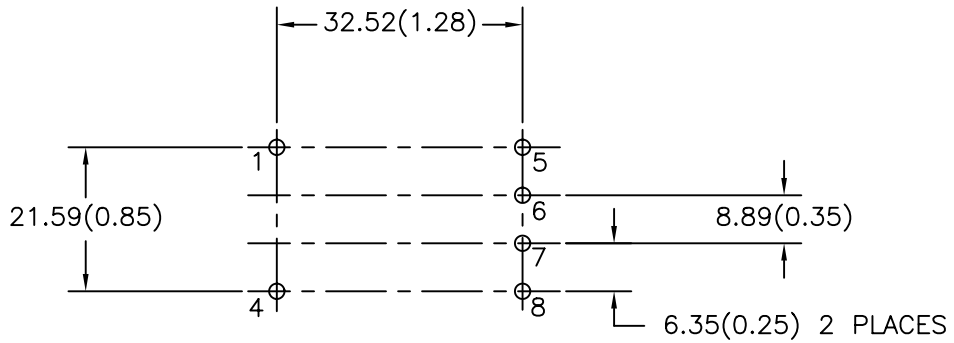

MODEL NUMBER

3FS-4XX & PSS4-XX

F. Schematic Diagram:

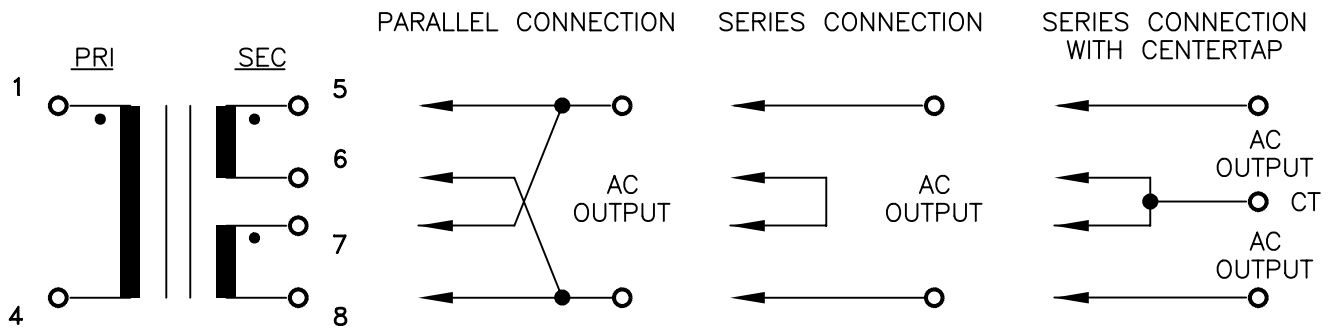

G. Table A: (NOTE: all parts are dual marked with both part numbers)

TAMURA PART NO.	MICROTRAN PART NO.	PARALLEL CONNECTION		SERIES CONNECTION		SERIES CONNECTION WITH CT	
		AC VOLTS	RMS AMPS	AC VOLTS	RMS AMPS	AC VOLTS	RMS AMPS
3FS-410	PSS4-10	5.0	1.20	10.0	0.60	5.0-CT-5.0	0.60
3FS-412	PSS4-12	6.3	1.00	12.6	0.50	6.3-CT-6.3	0.50
3FS-416	PSS4-16	8.0	0.80	16.0	0.40	8.0-CT-8.0	0.40
3FS-420	PSS4-20	10.0	0.60	20.0	0.30	10.0-CT-10.0	0.30
3FS-424	PSS4-24	12.0	0.50	24.0	0.25	12.0-CT-12.0	0.25
3FS-428	PSS4-28	14.0	0.40	28.0	0.20	14.0-CT-14.0	0.20
3FS-436	PSS4-36	18.0	0.34	36.0	0.17	18.0-CT-18.0	0.17
3FS-448	PSS4-48	24.0	0.25	48.0	0.125	24.0-CT-24.0	0.125
3FS-456	PSS4-56	28.0	0.22	56.0	0.11	28.0-CT-28.0	0.11
3FS-4120	PSS4-120	60.0	0.10	120.0	0.05	60.0-CT-60.0	0.05

PREPARED BY:

D. Rund

ENGINEER:

T. Shiozawa

QUALITY CONTROL:

D. Kelley

APPROVED:

D. Kelley

DRAWING CONTROL NO.
P-A1-11647
ACAD\3F\A1116472.DWG

REV

C

MODEL DESCRIPTION
SIZE 4 3FS/PSS FAMILY
POWER TRANSFORMER

TAMURA CORPORATION OF AMERICA

43352 BUSINESS PARK DRIVE, TEMECULA, CA. 92590-6624
(909) 699-1270 FAX 9096769482

MODEL SPECIFICATION

3FS-4XX & PSS4-XX

DIM: mm(In) SCL: NONE SH: 2 OF 2

PROPRIETARY NOTICE: THIS DRAWING PRINT OR DOCUMENT AND SUBJECT MATTER DISCLOSED HEREIN ARE PROPRIETARY ITEMS TO WHICH TAMURA RETAINS THE EXCLUSIVE RIGHT OF DISSEMINATION, REPRODUCTION, MANUFACTURE AND SALE. THIS DRAWING, PRINT OR DOCUMENT IS SUBMITTED IN CONFIDENCE FOR CONSIDERATION BY THE RECIPIENT ALONE UNLESS PERMISSION FOR FURTHER DISCLOSURE IS EXPRESSLY GRANTED IN WRITING.