

1. Electrical Specifications:

1-1 Input voltage: AC 198-264V rms, 47-63 Hz

1-2 Output voltage and current

OUTPUT	TOLERANCE	RIPPLE AND NOISE	OUTPUT CURRENT
6.0V	5.3-8.3V	200mV p-p MAX	0-2.0A

Note: (1) Output voltage to be measured after 30 secs. minimum warm-up with 2.0A load.

(2) This is specified at any combination of input voltage, frequency, load current, humidity, or temperature within their respective limits.

(3) Output ripple and noise to be measured with 100uF capacitor.

1-3 Input surge current 50A MAX under a cold start

1-4 Efficiency: 63% MIN with rated load.

1-5 Hold up time: 5 msec minimum at AC198V input, full load

1-6 Overload Protection is provided

1-7 Operating temperature and humidity: 0° C to +40° C, 10% to 90% humidity (non condensing)

1-8 Storage temperature and humidity: -10° C to +70° C, 5% to 95% humidity (non condensing)

1-9 Withstand voltage: AC 3000V rms 1 minute @ Input to Output

1-10 Insulation resistance: 50 M Ω minimum @ 500VDC Input to Output

1-11 EMI: VDE0871 Class B

2. Safety: IEC950

3. Mechanical Specifications:

50.4(1.985) MAX

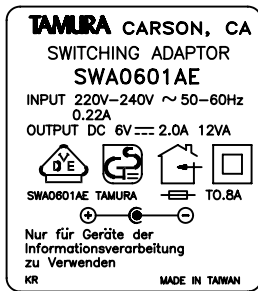

NAMEPLATE
TOP CASE
(SCALE:1/1)

AWG No. 20X2

1830(6 FT) MIN

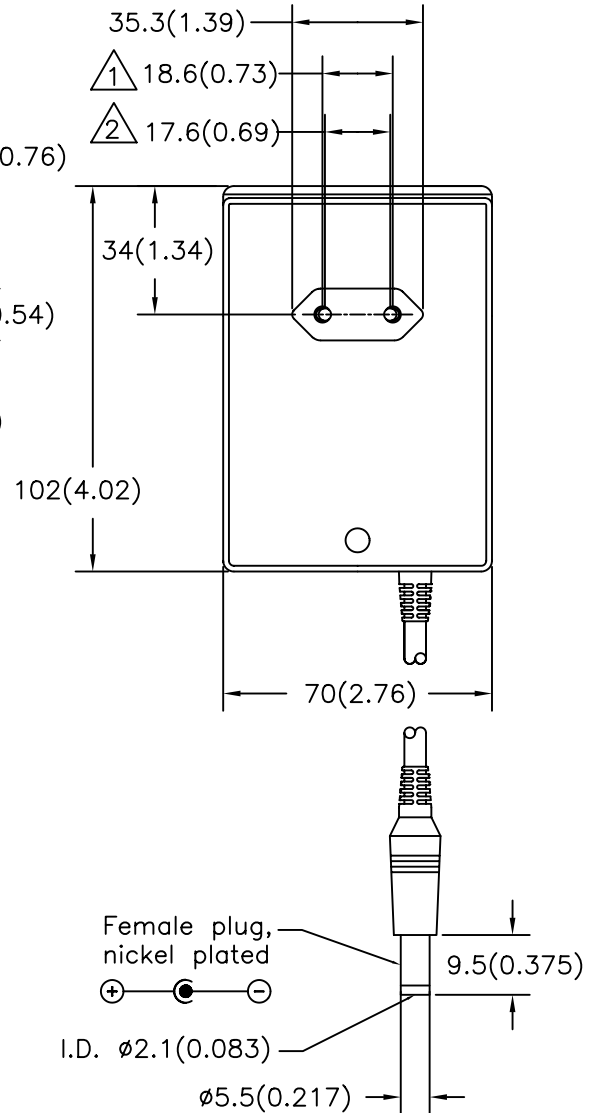

NOTES: UNLESS OTHERWISE SPECIFIED

① MEASURED AT PLUG ROOT

② MEASURED AT PLUG TIP

PREPARED: K. Georgeson ENGINEER:	DWG CONTROL NO. P-A7-10821 ACAD\SWA\A7108211.DWG	REV -	6V 2.0A POWER SUPPLY	SWA0601AE MODEL SPECIFICATION
APPROVED: D. Suzuki K.B. Creel	CONTENTS OF THIS DRAWING ARE SUBJECT TO CHANGE WITHOUT PRIOR NOTICE		TAMURA CORPORATION OF AMERICA 43352 BUSINESS PARK DRIVE, TEMECULA CA., 92590-6624 (909) 699-1270 FAX 9096769482	
<small>PROPRIETARY NOTICE: THIS DRAWING PRINT OR DOCUMENT AND SUBJECT MATTER DISCLOSED HEREIN ARE PROPRIETARY ITEMS TO WHICH TAMURA RETAINS THE EXCLUSIVE RIGHT OF DISSEMINATION, REPRODUCTION, MANUFACTURE AND SALE. THIS DRAWING, PRINT OR DOCUMENT IS SUBMITTED IN CONFIDENCE FOR CONSIDERATION BY THE RECIPIENT ALONE UNLESS PERMISSION FOR FURTHER DISCLOSURE IS EXPRESSLY GRANTED IN WRITING.</small>				