

Plastic Tube Container Dimensions

DIP, SDIP, SIP, ZIP, DMP, SDMP, TO, SOP, EMP, SOT, PLCC packages are packed in the plastic tube container. The dimensions are mentioned as follows.

1. Plastic Tube Container for dual-in-line plastic mold

(1) Plastic Tube Container dimensions for DIP8

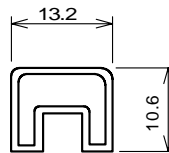
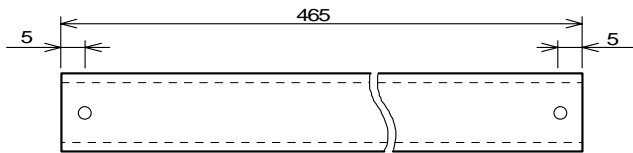

- 1. Material PVC
- 2. Stopper Stick Pin
- 3. Contents DIP8 50pcs/tube

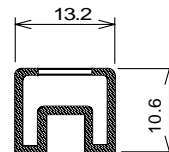
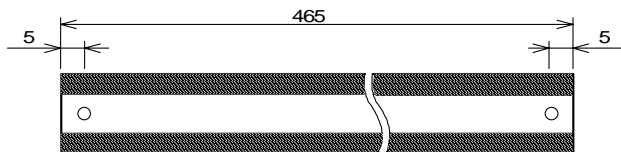

- 1. Material PS Carbon
- 2. Stopper Stick Pin
- 3. Contents DIP8 50pcs/tube

UNIT: mm

(2) Plastic Tube Container dimensions for DIP14/16

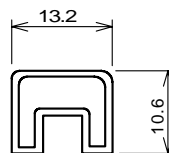
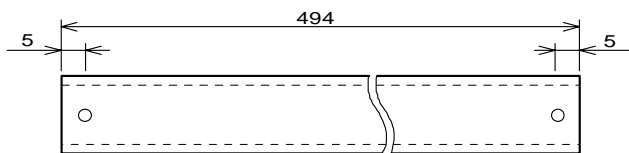

- 1. Material PVC
- 2. Stopper Stick Pin
- 3. Contents DIP14 25pcs/tube
DIP16 25pcs/tube

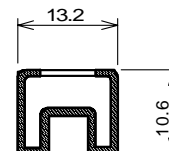
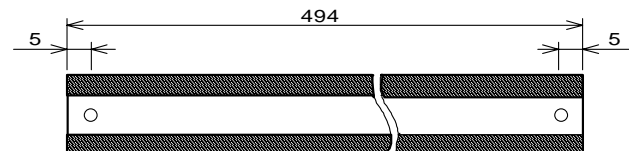

- 1. Material PS Carbon
- 2. Stopper Stick Pin
- 3. Contents DIP14 25pcs/tube
DIP16 25pcs/tube

UNIT: mm

PLASTIC TUBE DIMENSIONS

(3) Plastic Tube Container dimensions for DIP14-D1

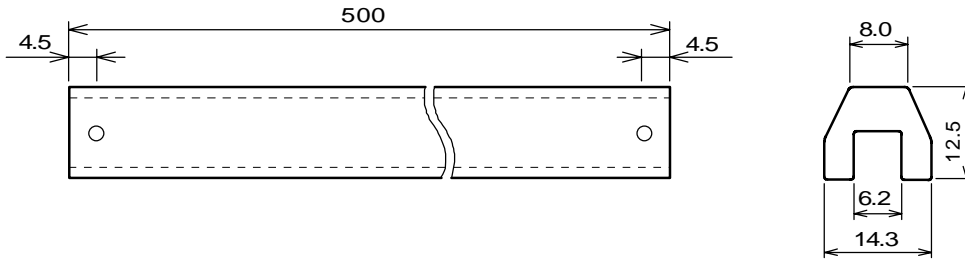

- | | |
|------------|---------------------|
| 1.Material | PVC |
| 2.Stopper | Stick Pin |
| 3.Contents | DIP14-D1 25pcs/tube |

UNIT: mm

UNIT: mm

PLASTIC TUBE DIMENSIONS

(4) Plastic Tube Container dimensions for DIP16-D2/D3

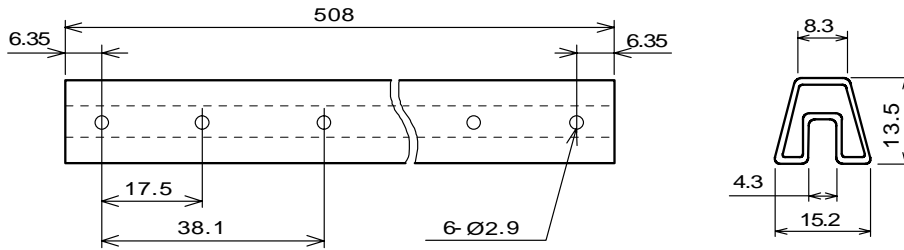

- 1.Thickness 0.5mm
- 2.Material PVC
- 3.Stopper Stick Pin
- 4.Contents DIP16-D2/D3 25pcs/tube

UNIT: mm

(5) Plastic Tube Container dimensions for DIP18/20

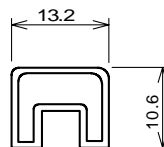
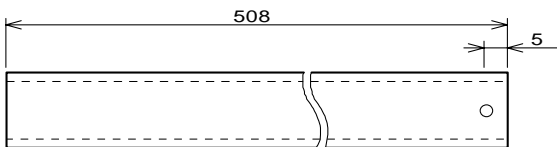

- 1.Material PVC
- 2.Stopper Stick Pin
- 3.Contents DIP18 20pcs/tube
DIP20 20pcs/tube

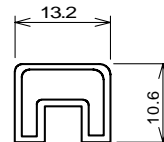
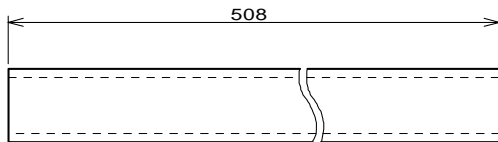

- 1.Material PVC
- 2.Stopper Rubber Knob
- 3.Contents DIP18 20pcs/tube
DIP20 20pcs/tube

UNIT: mm

PLASTIC TUBE DIMENSIONS

(6) Plastic Tube Container dimensions for DIP22

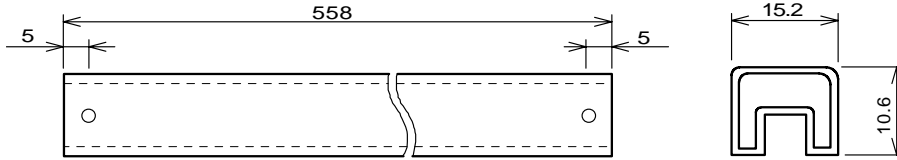

- | | |
|------------|------------------|
| 1.Material | PVC |
| 2.Stopper | Stick pin |
| 3.Contents | DIP22 20pcs/tube |

UNIT: mm

(7) Plastic Tube Container dimensions for DIP22-D2

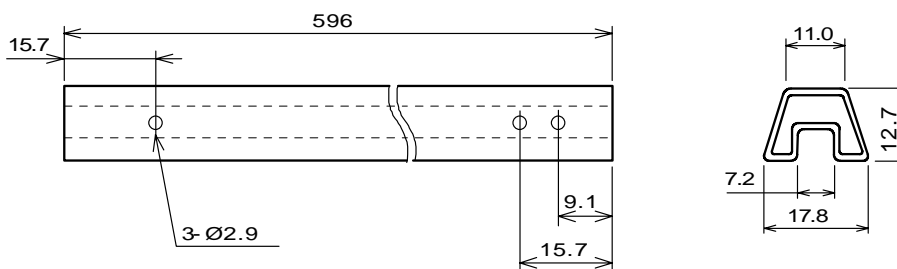

- | | |
|-------------|---------------------|
| 1.Thickness | 0.5mm |
| 2.Material | PVC |
| 3.Stopper | Stick Pin |
| 4.Contents | DIP22-D2 20pcs/tube |

UNIT: mm

PLASTIC TUBE DIMENSIONS

(8) Plastic Tube Container dimensions for DIP24-D2

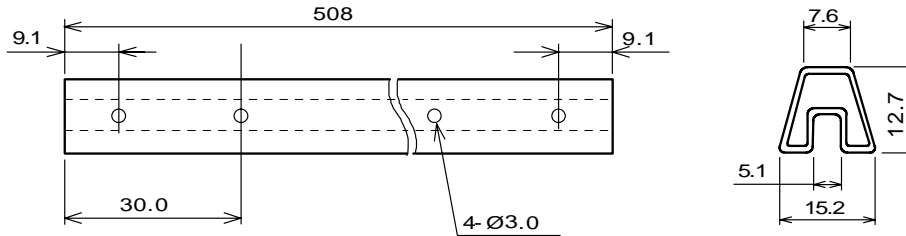

- 1.Thickness 0.5mm
- 2.Material PVC
- 3.Stopper Stick pin
- 4.Contents DIP24-D2 16pcs/tube

UNIT: mm

(9) Plastic Tube Container dimensions for DIP40

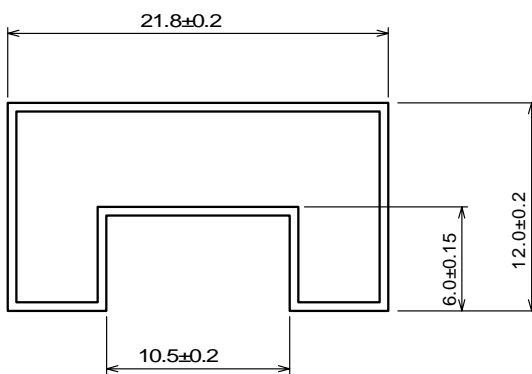

- 1.Length 550mm
- 2.Thickness 0.5mm
- 3.Material PVC
- 4.Stopper Rubber Knob
- 5.Contents DIP40 10pcs/tube

UNIT: mm

PLASTIC TUBE DIMENSIONS

2. Plastic Tube Container for shrunk dual-line plastic mold

(1) Plastic Tube Container dimensions for SDIP22

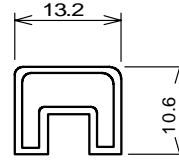
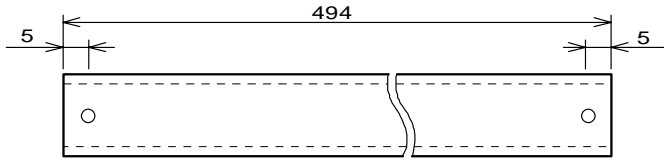

- 1. Material PVC
- 2. Stopper Stick pin
- 3. Contents SDIP22 25pcs/tube

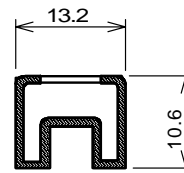
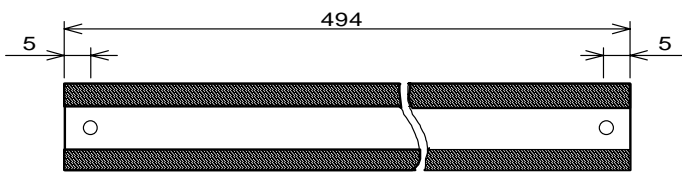

- 1. Material PS Carbon
- 2. Stopper Stick pin
- 3. Contents SDIP22 25pcs/tube

UNIT: mm

(2) Plastic Tube Container dimensions for SDIP24

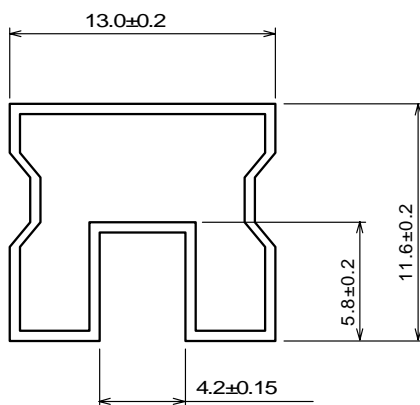

- 1. Length 505mm
- 2. Thickness 0.5mm
- 3. Material PVC
- 4. Stopper Rubber Knob
- 5. Contents SDIP24 20pcs/tube

UNIT: mm

PLASTIC TUBE DIMENSIONS

(3) Plastic Tube Container dimensions for SDIP28

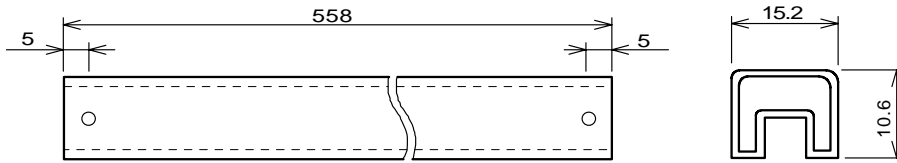

- 1. Material PVC
- 2. Stopper Stick Pin
- 3. Contents SDIP28 20pcs/tube

UNIT: mm

(4) Plastic Tube Container dimensions for SDIP30

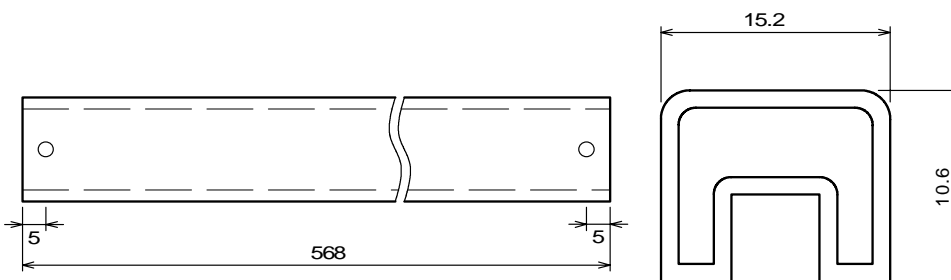

- 1. Material PVC
- 2. Stopper Stick Pin
- 3. Contents SDIP30 20pcs/tube

UNIT: mm

(5) Plastic Tube Container dimensions for SDIP42

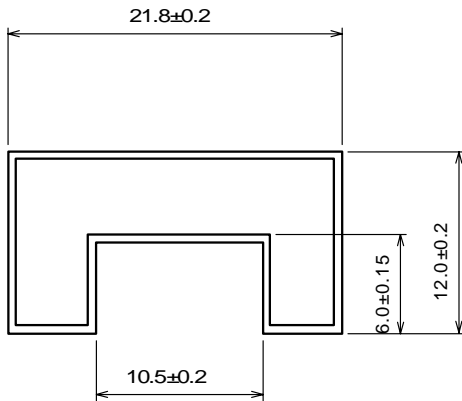

- 1.Length 550mm
- 2.Thickness 0.5mm
- 3.Material PVC
- 4.Stopper Rubber knob
- 5.Contents SDIP42 14pcs/tube

UNIT: mm

(6) Plastic Tube Container dimensions for SDIP56

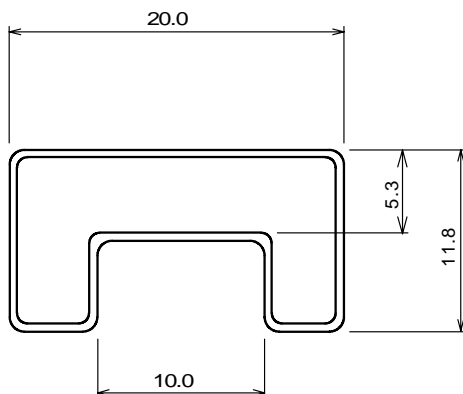

- 1.Length 558mm
- 2.Thickness 0.5mm
- 3.Material PVC
- 4.Stopper Rubber knob
- 5.Contents SDIP56 10pcs/tube

UNIT: mm

PLASTIC TUBE DIMENSIONS

3. Plastic Tube Container for single-in-line plastic mold

(1) Plastic Tube Container dimensions for SIP8

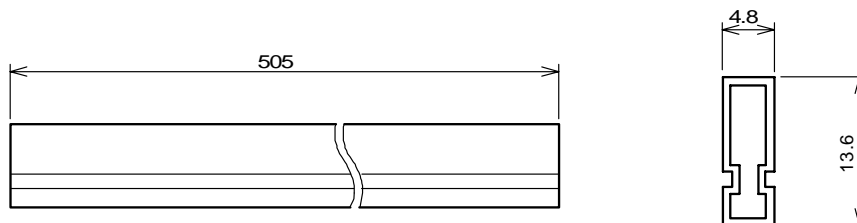

- | | |
|-------------|-----------------|
| 1.Thickness | 0.5 mm |
| 2.Material | PVC |
| 3.Stopper | Rubber Knob |
| 4.Contents | SIP8 25pcs/tube |

UNIT: mm

UNIT: mm

(3) Plastic Tube Container dimensions for ZIP16

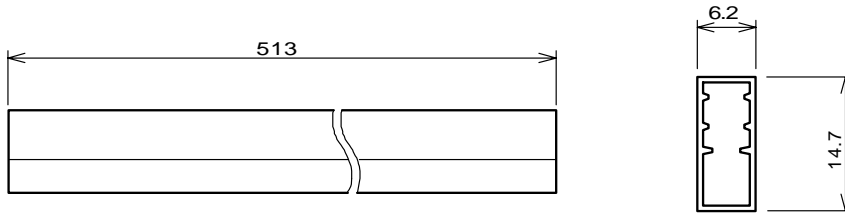

- | | |
|------------|------------------|
| 1.Material | PVC |
| 2.Stopper | Rubber Knob |
| 3.Contents | ZIP16 20pcs/tube |

UNIT: mm

4.Plastic Tube Container for dual-in-line plastic mini mold

(1) Plastic Tube Container dimensions for DMP8/14/16/20

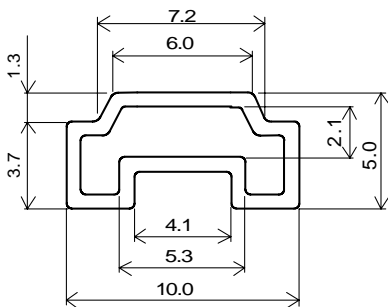

- | | |
|-------------|------------------------|
| 1.Length | 515 ± 2mm |
| 2.Thickness | 0.6mm |
| 3.Material | PVC |
| 4.Stopper | Rubber Knob |
| 5.Contents | DMP8 100pcs/tube |
| | DMP14/16/20 50pcs/tube |

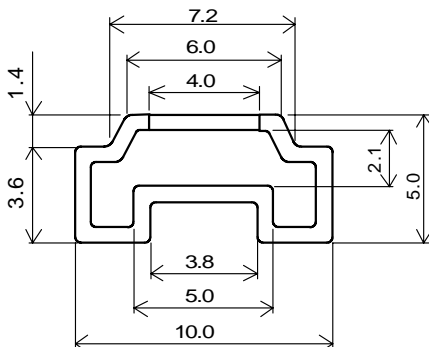

- | | |
|-------------|------------------------|
| 1.Length | 515 ± 2mm |
| 2.Thickness | 0.6mm |
| 3.Material | PS Carbon |
| 4.Stopper | Rubber Knob |
| 5.Contents | DMP8 100pcs/tube |
| | DMP14/16/20 50pcs/tube |

UNIT: mm

PLASTIC TUBE DIMENSIONS

(2) Plastic Tube Container dimensions for DMP24/SDMP30

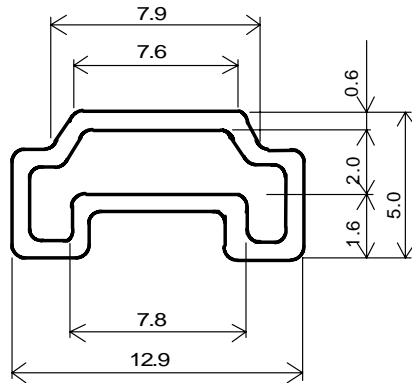

- 1.Length 410 ± 2mm
- 2.Thickness 0.6mm
- 3.Material PVC
- 4.Stopper Rubber Knob
- 5.Contents DMP24 25pcs/tube
 SDMP30 25pcs/tube

UNIT: mm

(3) Plastic Tube Container dimensions for SOP8

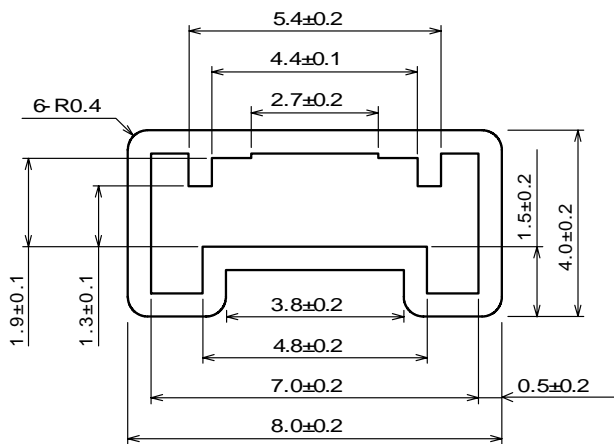

- 1.Length 280.5mm
- 2.Material PVC
- 3.Stopper Rubber Knob
- 4.Contents SOP8 50pcs/tube

UNIT: mm

PLASTIC TUBE DIMENSIONS

(4) Plastic Tube Container dimensions for SOP18

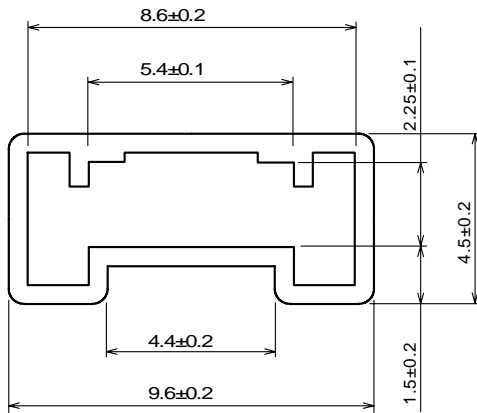

- 1.Length 400mm
- 2.Thickness 0.5mm
- 3.Material PVC
- 4.Stopper Rubber Knob
- 5.Contents SOP18 25pcs/tube

UNIT: mm

(5) Plastic Tube Container dimensions for SOP20

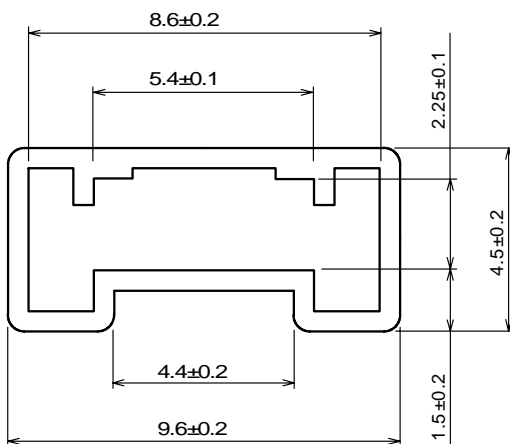

- 1.Length 400mm
- 2.Thickness 0.5mm
- 3.Material PVC
- 4.Stopper Rubber Knob
- 5.Contents SOP20 25pcs/tube

UNIT: mm

PLASTIC TUBE DIMENSIONS

(6) Plastic Tube Container dimensions for SOP22

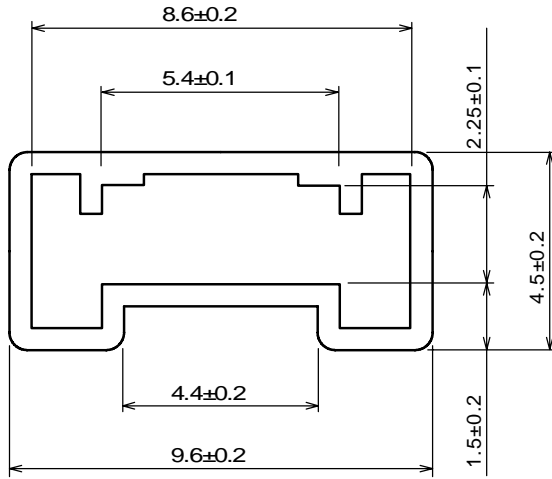

- 1.Length 400mm
- 2.Thickness 0.5mm
- 3.Material PVC
- 4.Stopper Rubber Knob
- 5.Contents SOP22 25pcs/tube

UNIT: mm

UNIT: mm

PLASTIC TUBE DIMENSIONS

(7) Plastic Tube Container dimensions for SOP28

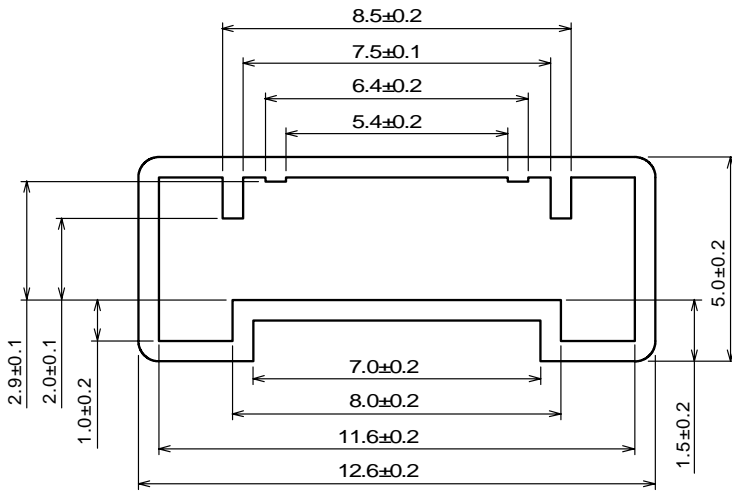

- 1.Length 400mm
- 2.Thickness 0.5mm
- 3.Material PVC
- 4.Stopper Rubber Knob
- 5.Contents SOP28 20pcs/tube

UNIT: mm

(8) Plastic Tube Container dimensions for SOP40

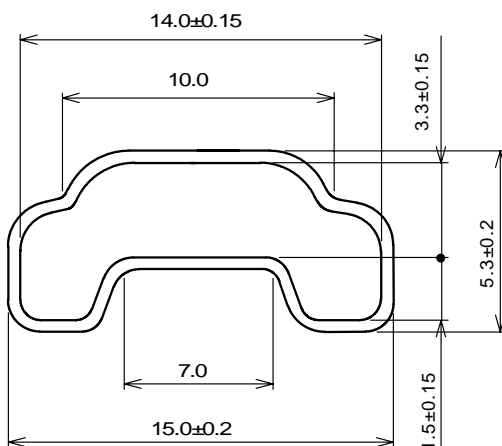

- 1.Length 430mm
- 2.Material PVC
- 3.Stopper Rubber Knob
- 4.Contents SOP40 15pcs/tube

UNIT: mm

PLASTIC TUBE DIMENSIONS

(9) Plastic Tube Container dimensions for EMP8/14

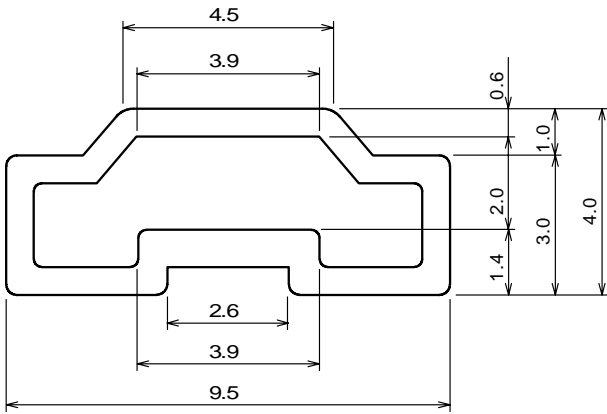

- | | | |
|------------|-------------|-------------|
| 1.Length | EMP8 | 508mm |
| | EMP14 | 451mm |
| 2.Material | PVC | |
| 3.Stopper | Rubber Knob | |
| 4.Contents | EMP8 | 100pcs/tube |
| | EMP14 | 50pcs/tube |

UNIT: mm

(10) Plastic Tube Container dimensions for EMP16-E2/20-E2/24-E3

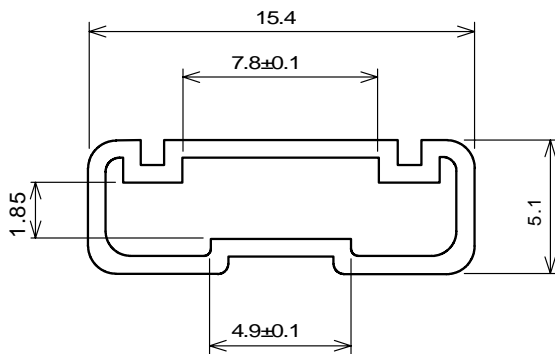

- | | | |
|-------------|----------------|------------|
| 1.Length | EMP16-E2/20-E2 | 540mm |
| | EMP24-E3 | 410mm |
| 2.Thickness | 0.7mm | |
| 3.Material | PVC | |
| 4.Stopper | Stick Pin | |
| 5.Contents | EMP16-E2 | 50pcs/tube |
| | EMP20-E2 | 40pcs/tube |
| | EMP24-E3 | 25pcs/tube |

UNIT: mm

5. Plastic Tube Container for Transistor outline

(1) Plastic Tube Container dimensions for TO-220(5pin)Straight Type

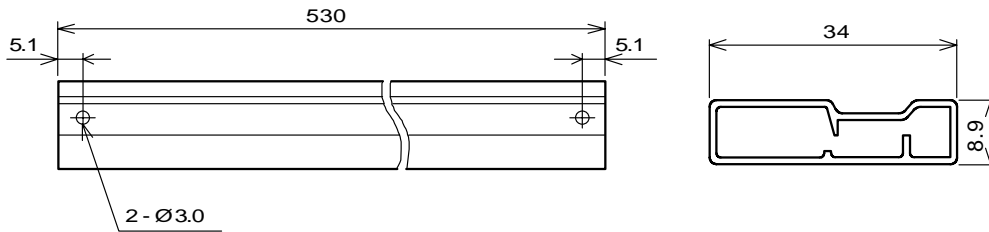

- 1. Material PVC
- 2. Stopper Stick Pin
- 3. Contents TO-220-5(Straight Type) 50pcs/tube

UNIT: mm

(2) Plastic Tube Container dimensions for TO-220(5pin)Forming Type

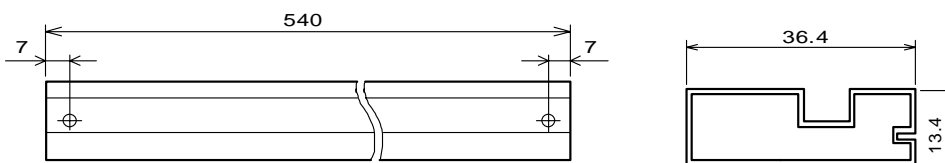

- 1. Material PVC
- 2. Stopper Stick Pin
- 3. Contents TO-220-5(Forming Type) 50pcs/tube

UNIT: mm

PLASTIC TUBE DIMENSIONS

(3) Plastic Tube Container dimensions for TO-220F(4pin)Straight Type

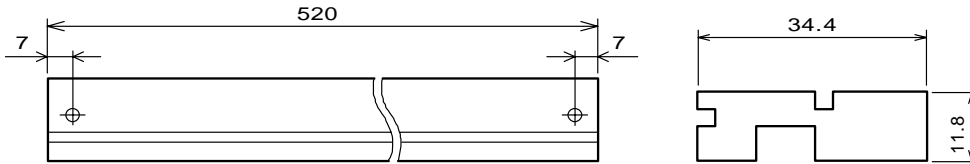

- 1.Material PVC
- 2.Stopper Stick Pin
- 3.Contents TO-220F-4(Straight Type) 50pcs/tube

UNIT: mm

(4) Plastic Tube Container dimensions for TO-220F(4pin)Forming Type



- 1.Material PVC
- 2.Stopper Stick Pin
- 3.Contents TO-220F-4(Forming Type) 50pcs/tube

UNIT: mm

6. Plastic Tube Container for Small outline transistor

(1) Plastic Tube Container dimensions for SOT89

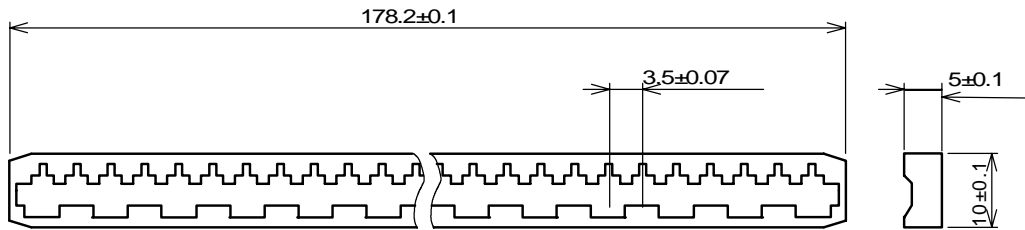

- | | |
|-------------|------------------|
| 1. Material | PVC |
| 2. Contents | SOT89 25pcs/tube |

UNIT: mm

7. Plastic Tube Container for Plastic leadless chip carrier

(1) Plastic Tube Container dimensions for PLCC28-M2

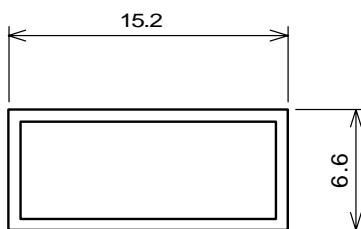

- | | |
|--------------|----------------------|
| 1. Length | 532mm |
| 2. Thickness | 0.76mm |
| 3. Material | PVC |
| 4. Stopper | Rubber Knob |
| 5. Contents | PLCC28-M2 40pcs/tube |

UNIT: mm